

1 - ATTIC CRITICAL DETAIL : AIR SEALING A CHASE

EXISTING HOME TECH TIPS

(SPRAY FOAM)



DESIRED OUTCOME(S)

1. Air does not enter or exit the house through the chase.
2. Eliminate bending, sagging or movement.
3. Adhesion of sealants to all surfaces to be air sealed in order to stop the passage of air.

EFFECTS ON THE HOUSE

Openings to the attic allow heat, cold and moisture movement to/from the attic and house and may result in decreased durability.

EFFECTS ON THE OCCUPANTS

Intrusion of unhealthy air from unconditioned areas, reduced comfort, possible back drafts containing poisonous fumes and higher utility bills.

MATERIALS

Filler Material

Support Material

Fasteners

Sealants

TOOLS

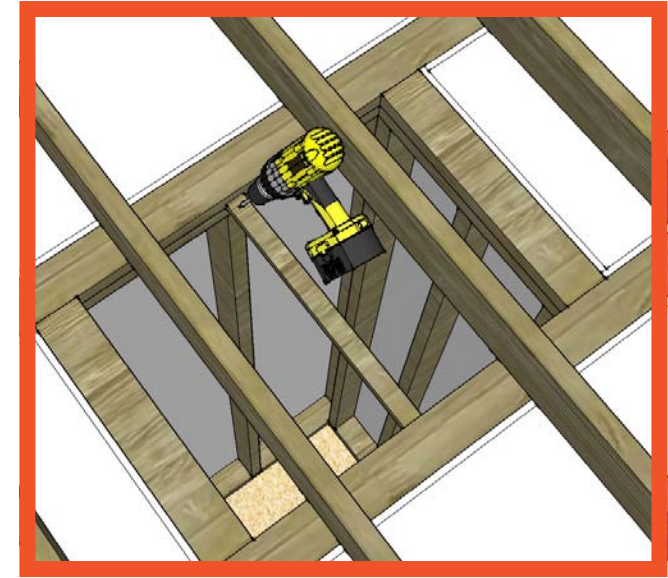
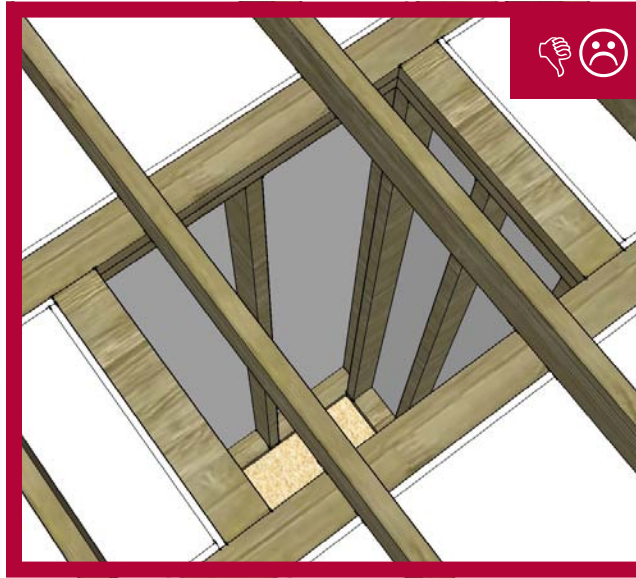

SAFETY

- Before entering attic or cutting, put on all personal protection equipment. *This is to reduce the amount of dust particles you breathe, protect your eyes and hands.*

JOB PREP

- Measure size and cut [filler material](#) larger than opening in all directions. *If [filler material](#) bends, sags, or moves when in place, a support material must be used.*
- If needed, cut [support material](#). *[Support material](#) must not sag or bend when fastened.*
- Fasten any [support material](#) in place.

DO NOT USE NAILS

1 - ATTIC CRITICAL DETAIL : AIR SEALING A CHASE

EXISTING HOME TECH TIPS

(SPRAY FOAM)

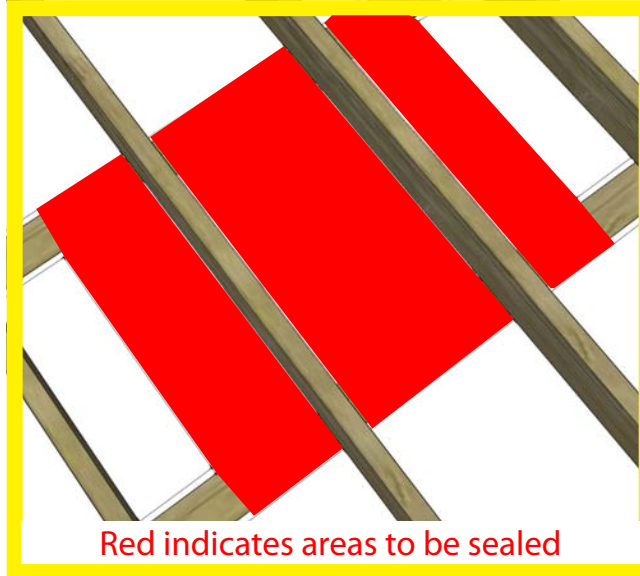
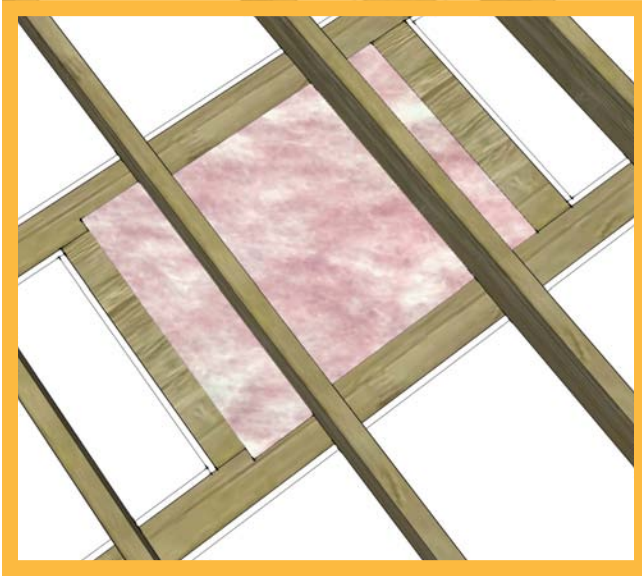

Red indicates areas to be sealed

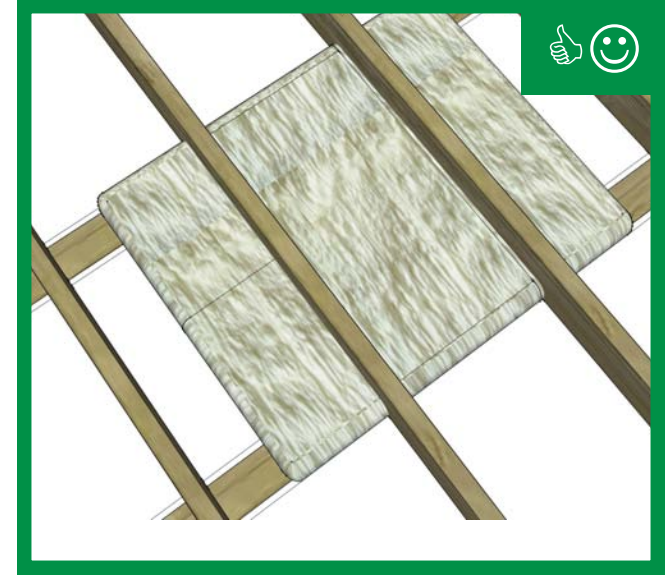

FILLER MATERIAL

- Install [filler material](#).

AIR SEALING

- Spray foam. Assure 100% of the edge and all penetrations are air sealed. The finished foam seal must be rigid and completely covering the [filler material](#).

FINAL PRODUCT

2 - ATTIC CRITICAL DETAIL: DROPPED CEILING



EXISTING HOME TECH TIPS

(SPRAY FOAM)

DESIRED OUTCOME(S)

1. Air does not enter or exit the house through the dropped ceiling.
2. Eliminate bending, sagging or movement.
3. Adhesion of sealants to all surfaces to be air sealed in order to stop the passage of air.

EFFECTS ON THE HOUSE

Openings to the attic allow heat, cold and moisture movement to/from the attic and house and may result in decreased durability.

EFFECTS ON THE OCCUPANTS

Intrusion of unhealthy air from unconditioned areas, reduced comfort, possible back drafts containing poisonous fumes and higher utility bills.

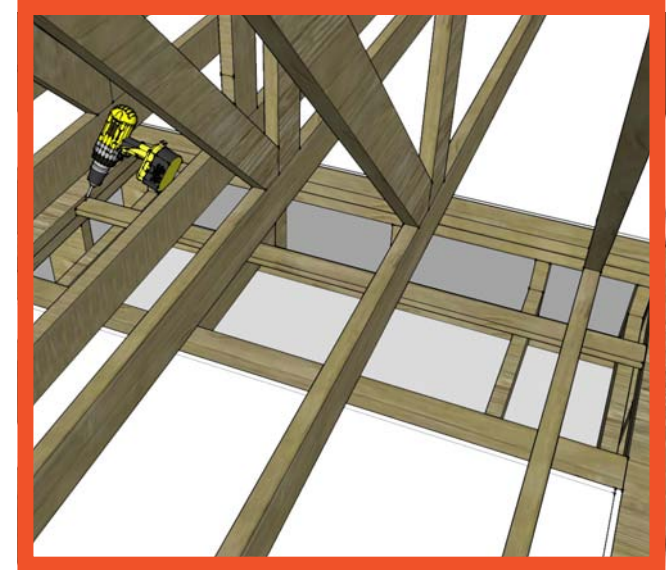
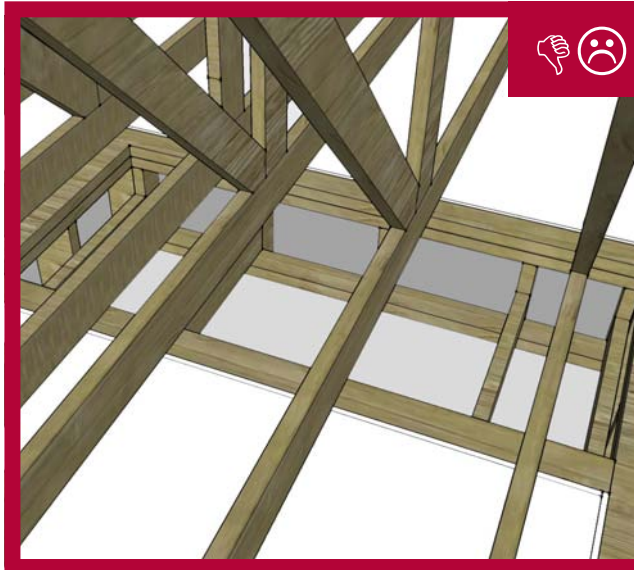

SAFETY

- Before entering attic or cutting, put on all personal protection equipment. *This is to reduce the amount of dust particles you breathe, protect your eyes and hands.*

JOB PREP

- Measure size and cut [filler material](#) larger than opening in all directions. *If [filler material](#) bends, sags, or moves when in place, a support material must be used.*
- If needed, cut [support material](#). *[Support material](#) must not sag or bend when fastened.*
- Fasten any [support material](#) in place.

DO NOT USE NAILS

MATERIALS

Filler Material

Support Material

Fasteners

Sealants

TOOLS

2 - ATTIC CRITICAL DETAIL: DROPPED CEILING

EXISTING HOME TECH TIPS

(SPRAY FOAM)

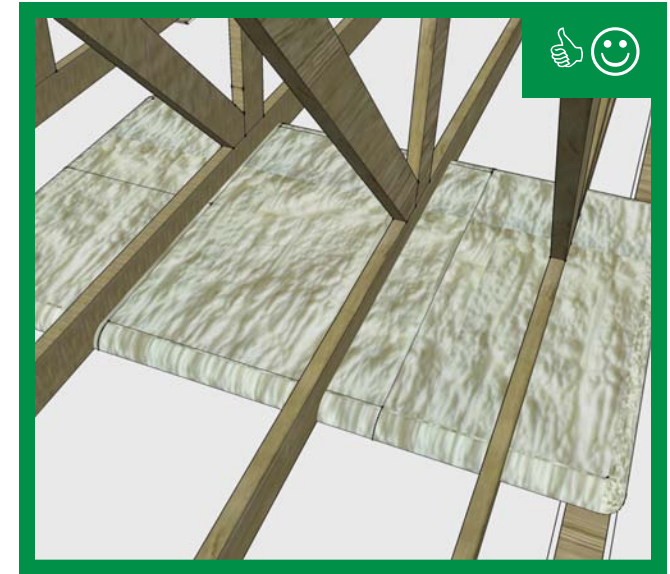
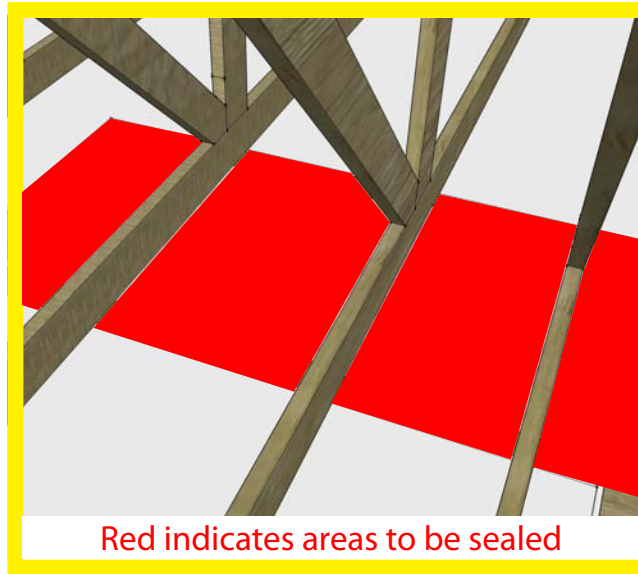
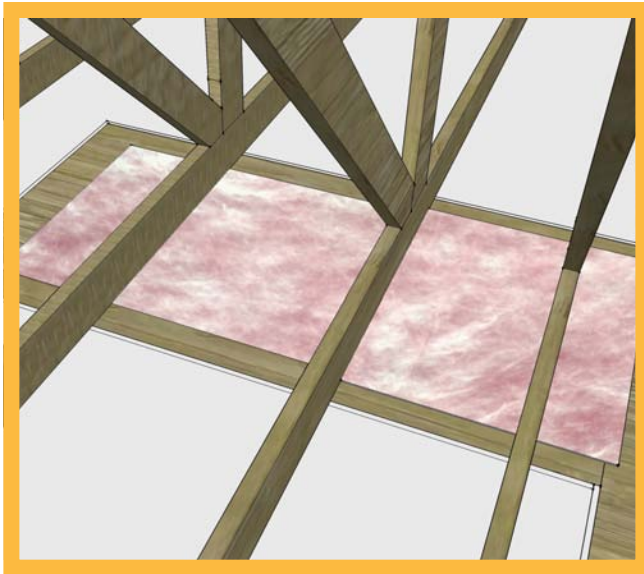

FILLER MATERIAL

- Install [filler material](#).

AIR SEALING

- Spray foam. Assure 100% of the edge and all penetrations are air sealed. The finished foam seal must be rigid and completely covering the [filler material](#).

FINAL PRODUCT

3 - ATTIC CRITICAL DETAIL: SOFFIT, FURRED-DOWN OR BULKHEAD



EXISTING HOME TECH TIPS

(SPRAY FOAM)

DESIRED OUTCOME(S)

1. Air does not enter or exit the house through the soffit, furred-down or bulkhead.
2. Eliminate bending, sagging or movement.
3. Adhesion of sealants to all surfaces to be air sealed in order to stop the passage of air.

EFFECTS ON THE HOUSE

Openings to the attic allow heat, cold and moisture movement to/from the attic and house and may result in decreased durability.

EFFECTS ON THE OCCUPANTS

Intrusion of unhealthy air from unconditioned areas, reduced comfort, possible back drafts containing poisonous fumes and higher utility bills.

MATERIALS

Filler Material

Support Material

Fasteners

Sealants

TOOLS

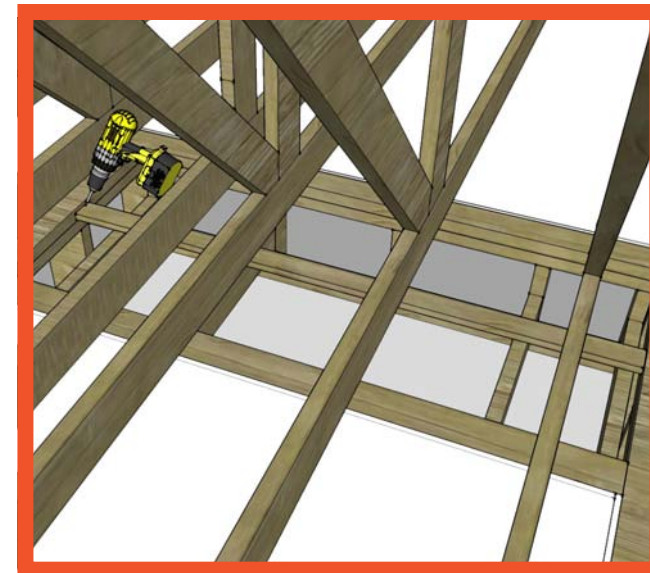
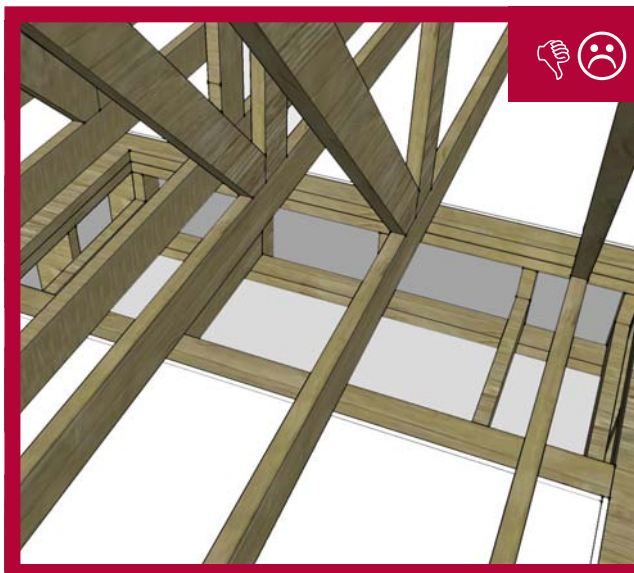

SAFETY

- Before entering attic or cutting, put on all personal protection equipment. *This is to reduce the amount of dust particles you breathe, protect your eyes and hands.*

JOB PREP

- Measure size and cut [filler material](#) larger than opening in all directions. *If [filler material](#) bends, sags, or moves when in place, a support material must be used.*
- If needed, cut [support material](#). *[Support material](#) must not sag or bend when fastened.*
- Fasten any [support material](#) in place.

DO NOT USE NAILS

3 - ATTIC CRITICAL DETAIL: SOFFIT, FURRED-DOWN OR BULKHEAD

EXISTING HOME TECH TIPS

(SPRAY FOAM)

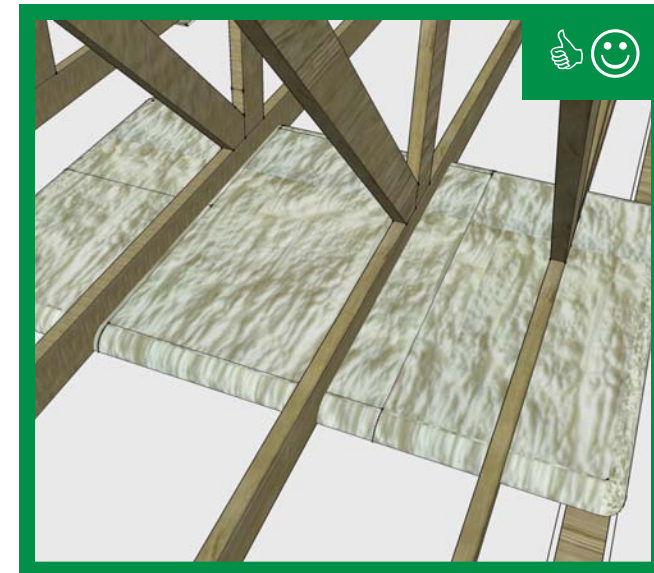
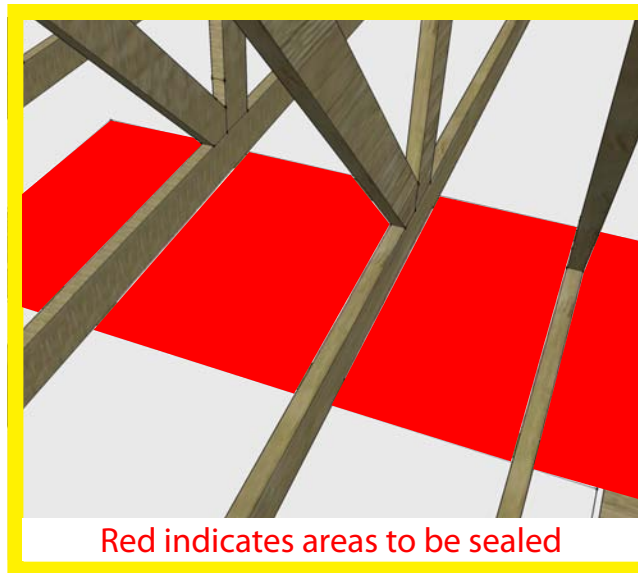
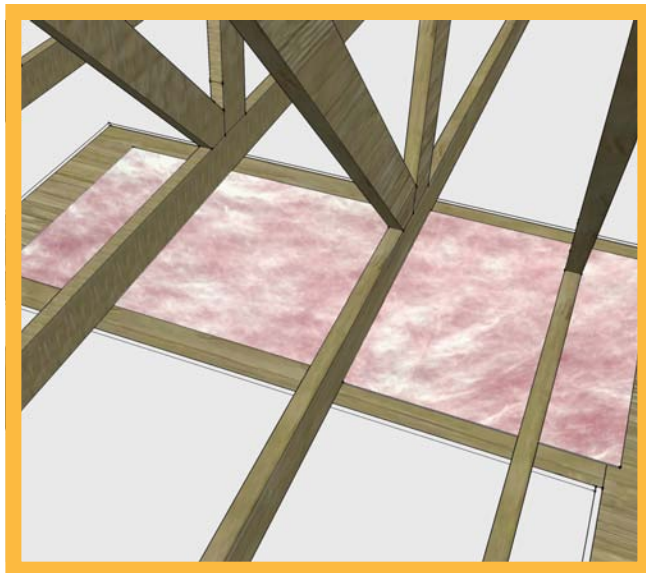

FILLER MATERIAL

- Install [filler material](#).

AIR SEALING

- Spray foam. Assure 100% of the edge and all penetrations are air sealed. The finished foam seal must be rigid and completely covering the [filler material](#).

FINAL PRODUCT

4 - ATTIC CRITICAL DETAIL: OPEN STAIRWELL

EXISTING HOME TECH TIPS

(SPRAY FOAM))



DESIRED OUTCOME(S)

1. Air does not enter or exit the house through the open stairwell.
2. Eliminate bending, sagging or movement.
3. Adhesion of sealants to all surfaces to be air sealed in order to stop the passage of air.

EFFECTS ON THE HOUSE

Openings to the attic allow heat, cold and moisture movement to/from the attic and house and may result in decreased durability.

EFFECTS ON THE OCCUPANTS

Intrusion of unhealthy air from unconditioned areas, reduced comfort, possible back drafts containing poisonous fumes and higher utility bills.

MATERIALS

Filler Material

Support Material

Fasteners

Sealants

TOOLS

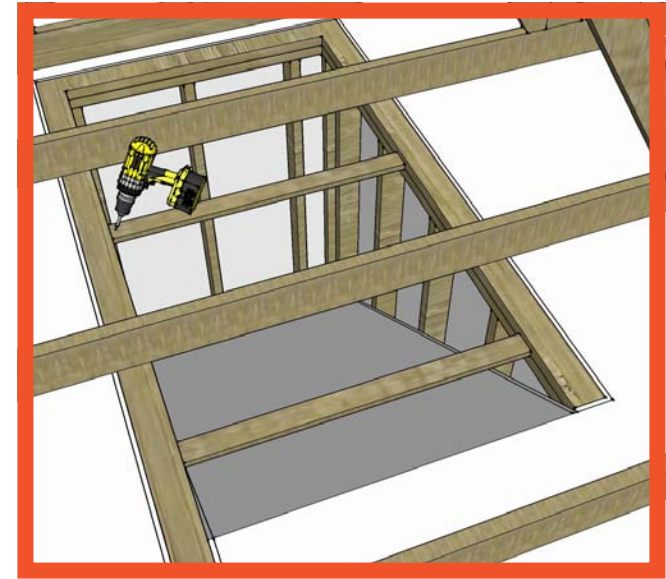
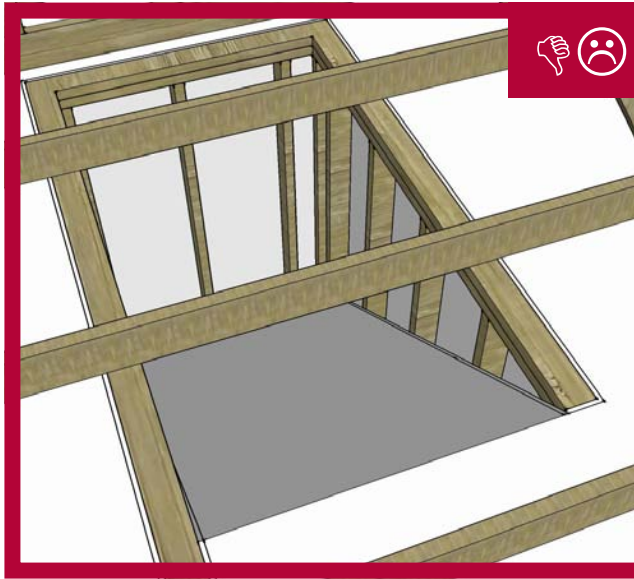

SAFETY

- Before entering attic or cutting, put on all personal protection equipment. *This is to reduce the amount of dust particles you breathe, protect your eyes and hands.*

JOB PREP

- Measure size and cut [filler material](#) larger than opening in all directions. *If [filler material](#) bends, sags, or moves when in place, a support material must be used.*
- If needed, cut [support material](#). *[Support material](#) must not sag or bend when fastened.*
- Fasten any [support material](#) in place.

DO NOT USE NAILS

4 - ATTIC CRITICAL DETAIL: OPEN STAIRWELL

EXISTING HOME TECH TIPS

(SPRAY FOAM)

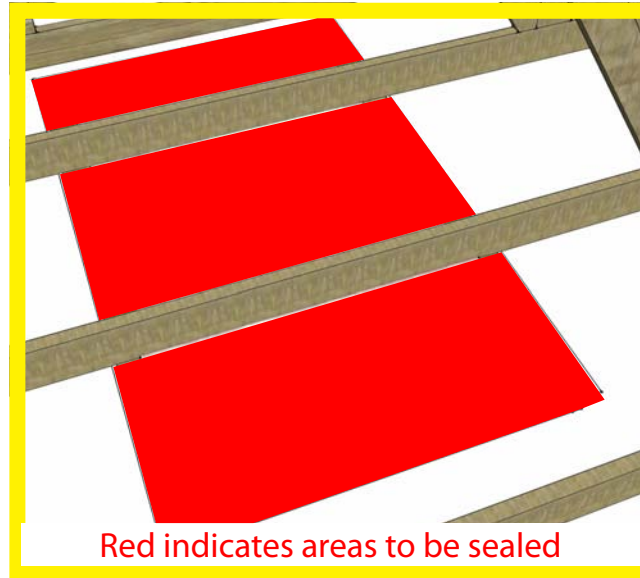
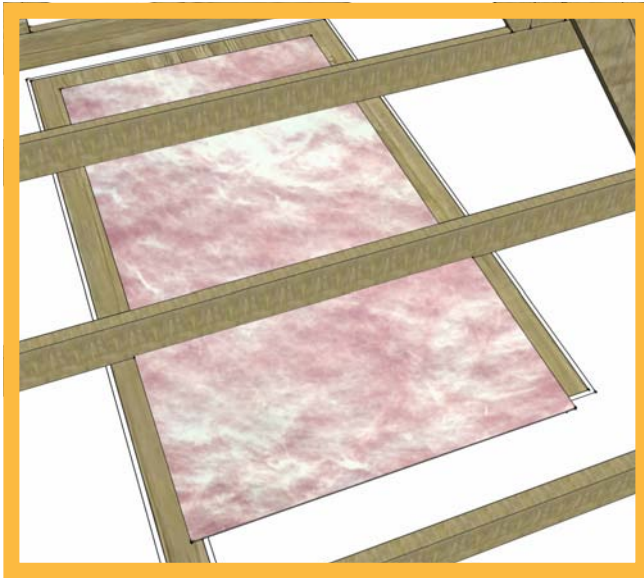

FILLER MATERIAL

- Install [filler material](#).

AIR SEALING

- Spray foam. *Assure 100% of the edge and all penetrations are air sealed. The finished foam seal must be rigid and completely covering the [filler material](#).*

FINAL PRODUCT

5 - ATTIC CRITICAL DETAIL: OPEN WALL CAVITY



EXISTING HOME TECH TIPS

(SPRAY FOAM)

DESIRED OUTCOME(S)

1. Air does not enter or exit the house through the open wall cavity.
2. Eliminate bending, sagging or movement.
3. Adhesion of sealants to all surfaces to be air sealed in order to stop the passage of air.

EFFECTS ON THE HOUSE

Openings to the attic allow heat, cold and moisture movement to/from the attic and house and may result in decreased durability.

EFFECTS ON THE OCCUPANTS

Intrusion of unhealthy air from unconditioned areas, reduced comfort, possible back drafts containing poisonous fumes and higher utility bills.

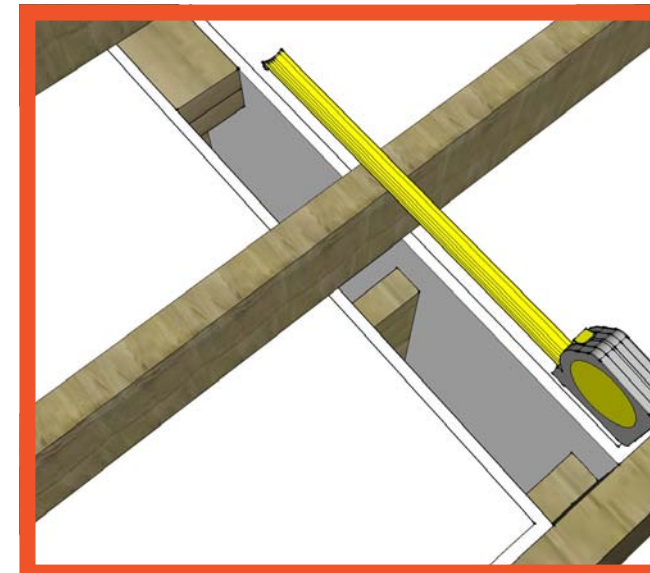
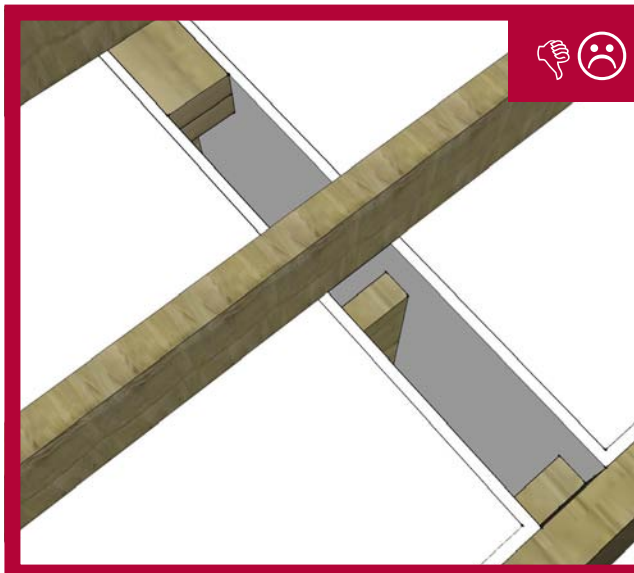

SAFETY

- Before entering attic or cutting, put on all personal protection equipment. *This is to reduce the amount of dust particles you breathe, protect your eyes and hands.*

JOB PREP

- Measure size and cut [filler material](#) larger than opening in all directions.

MATERIALS

Filler Material

Support Material

Fasteners

Sealants

TOOLS

5 - ATTIC CRITICAL DETAIL: OPEN WALL CAVITY

EXISTING HOME TECH TIPS

(SPRAY FOAM)

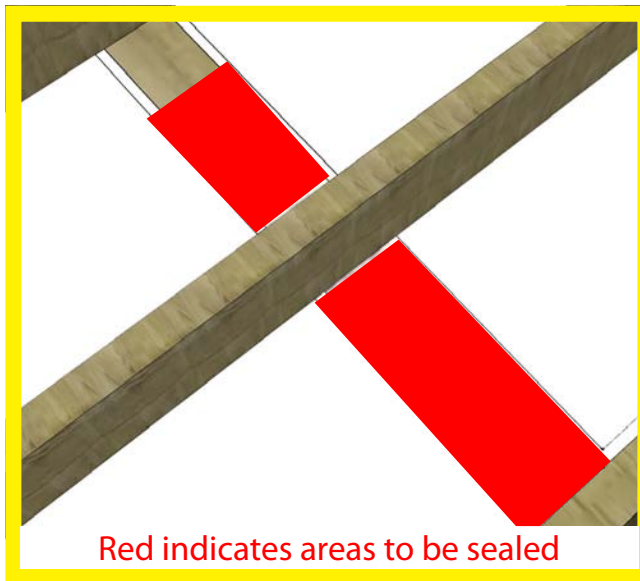
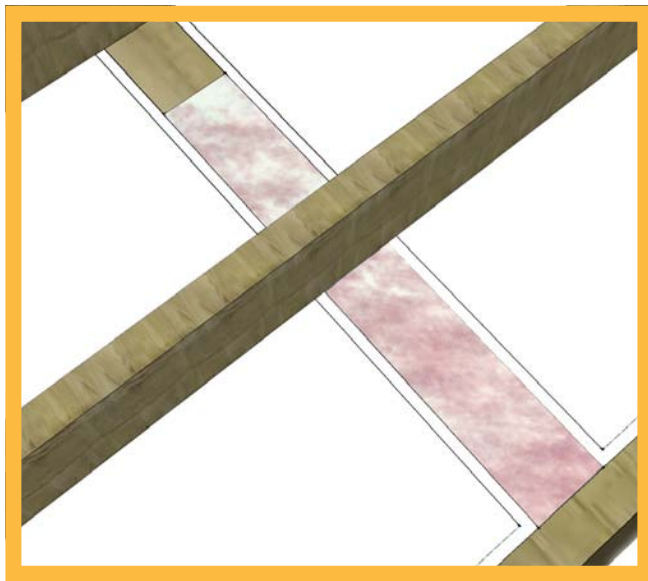

Red indicates areas to be sealed



FILLER MATERIAL

- Install [filler material](#).

AIR SEALING

- Spray foam. *Assure 100% of the edge and all penetrations are air sealed. The finished foam seal must be rigid and completely covering the [filler material](#).*

FINAL PRODUCT

6 - ATTIC CRITICAL DETAIL: OPEN FLOOR SYSTEM



EXISTING HOME TECH TIPS

(SPRAY FOAM)

DESIRED OUTCOME(S)

1. Air does not enter or exit the house through the open floor system.
2. Eliminate bending, sagging or movement.
3. Adhesion of sealants to all surfaces to be air sealed in order to stop the passage of air.

EFFECTS ON THE HOUSE

Openings to the attic allow heat, cold and moisture movement to/from the attic and house and may result in decreased durability.

EFFECTS ON THE OCCUPANTS

Intrusion of unhealthy air from unconditioned areas, reduced comfort, possible back drafts containing poisonous fumes and higher utility bills.

MATERIALS

Filler Material

Support Material

Fasteners

Sealants

TOOLS

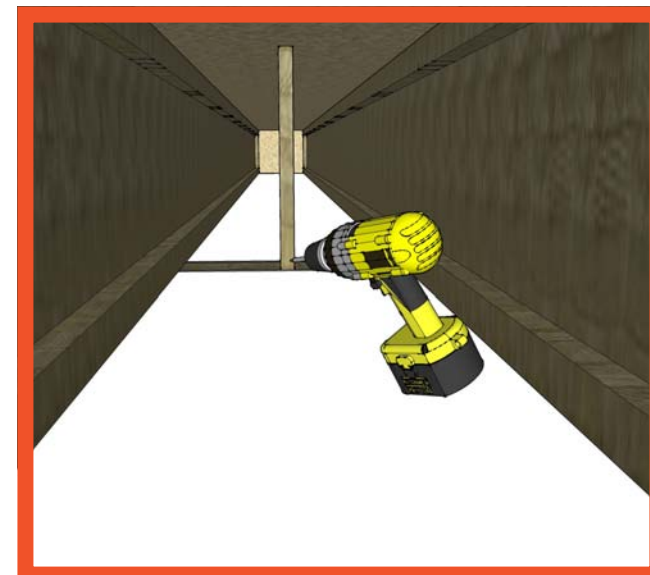

SAFETY

- Before entering attic or cutting, put on all personal protection equipment. *This is to reduce the amount of dust particles you breathe, protect your eyes and hands.*

JOB PREP

- Measure size and cut [filler material](#) larger than opening in all directions. *If [filler material](#) bends, sags, or moves when in place, a support material must be used.*
- If needed, cut [support material](#). *[Support material](#) must not sag or bend when fastened.*
- Fasten any [support material](#) in place.

DO NOT USE NAILS

6 - ATTIC CRITICAL DETAIL: OPEN FLOOR SYSTEM

EXISTING HOME TECH TIPS

(SPRAY FOAM)

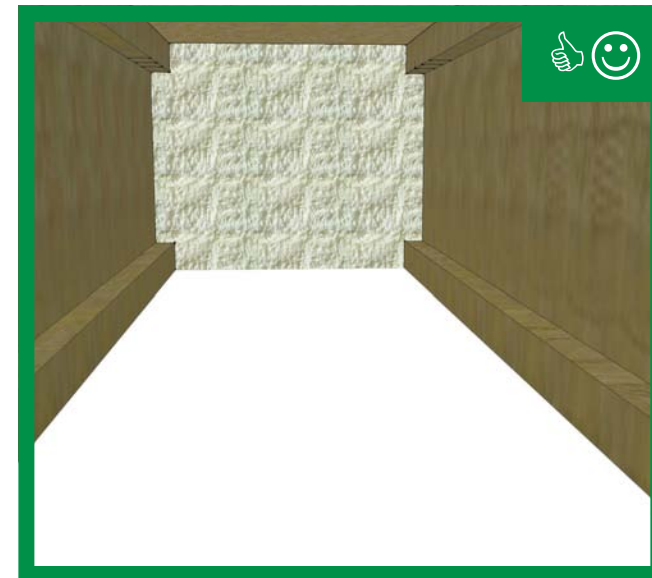
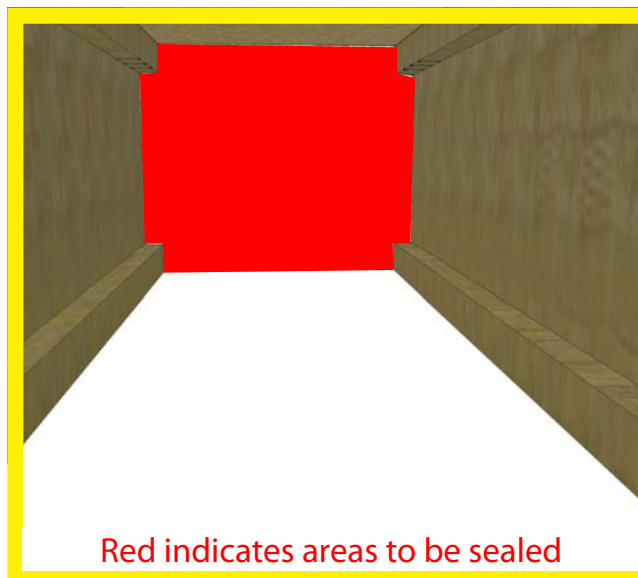
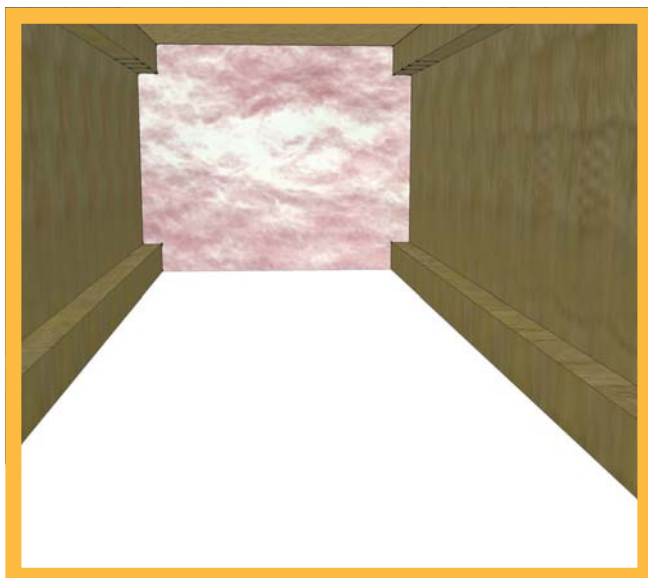

FILLER MATERIAL

- Install [filler material](#).

AIR SEALING

- Spray foam. Assure 100% of the edge and all penetrations are air sealed. The finished foam seal must be rigid and completely covering the [filler material](#).

FINAL PRODUCT

7 - ATTIC CRITICAL DETAIL: WALL TOP PLATE CRACKS, HOLES, & PENETRATIONS



EXISTING HOME TECH TIPS

(SPRAY FOAM)

DESIRED OUTCOME(S)

1. Air does not enter or exit the house through wall top plate cracks, holes and penetrations.
2. Adhesion of sealants to all surfaces to be air sealed in order to stop the passage of air.

EFFECTS ON THE HOUSE

Openings to the attic allow heat, cold and moisture movement to/from the attic and house and may result in decreased durability.

EFFECTS ON THE OCCUPANTS

Intrusion of unhealthy air from unconditioned areas, reduced comfort, possible back drafts containing poisonous fumes and higher utility bills.

MATERIALS

Filler Material

Support Material

Fasteners

Sealants

TOOLS

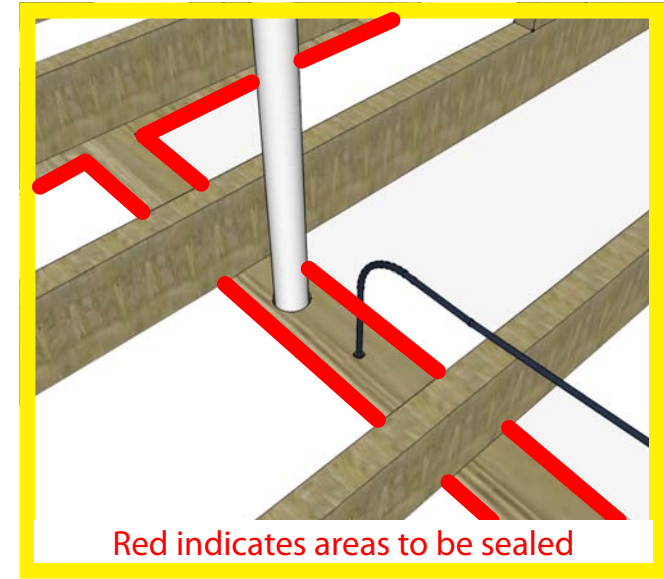
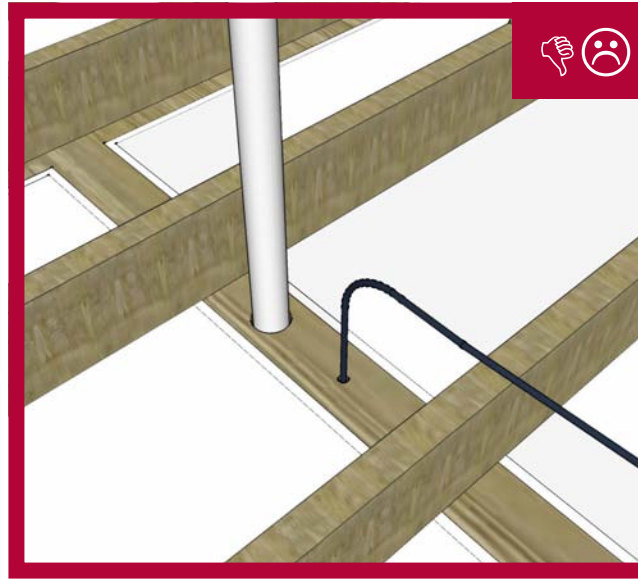

Red indicates areas to be sealed

SAFETY

- Before entering attic or cutting, put on all personal protection equipment. *This is to reduce the amount of dust particles you breathe, protect your eyes and hands.*

AIR SEALING

- Spray foam. *Assure 100% of the edge and all penetrations are air sealed. The finished foam seal must be rigid and completely covering wall top plate cracks, holes and penetrations.*

7 - ATTIC CRITICAL DETAIL: WALL TOP PLATE CRACKS, HOLES, & PENETRATIONS

EXISTING HOME TECH TIPS

(SPRAY FOAM)

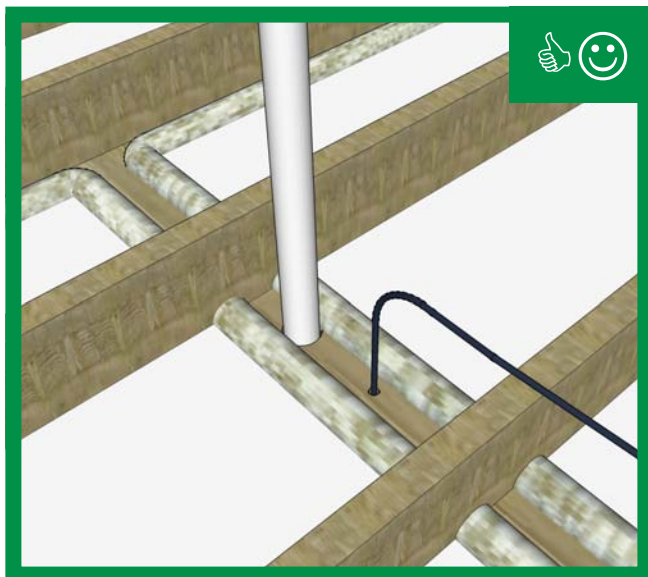

FINAL PRODUCT



8 - ATTIC CRITICAL DETAIL: ADJACENT FRAMING CRACKS, HOLES, & PENETRATIONS



EXISTING HOME TECH TIPS

(SPRAY FOAM)

DESIRED OUTCOME(S)

1. Air does not enter or exit the house through adjacent framing cracks, holes and penetrations
2. Adhesion of sealants to all surfaces to be air sealed in order to stop the passage of air.

EFFECTS ON THE HOUSE

Openings to the attic allow heat, cold and moisture movement to/from the attic and house and may result in decreased durability.

EFFECTS ON THE OCCUPANTS

Intrusion of unhealthy air from unconditioned areas, reduced comfort, possible back drafts containing poisonous fumes and higher utility bills.

MATERIALS

Filler Material

Support Material

Fasteners

Sealants

TOOLS

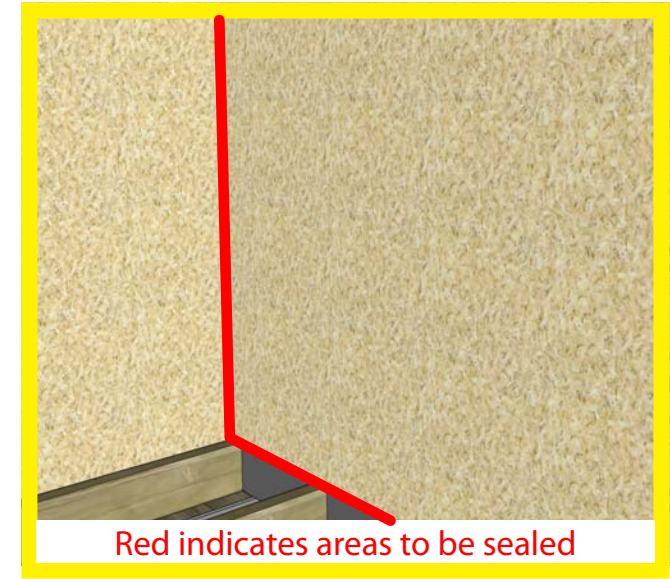

Red indicates areas to be sealed

SAFETY

- Before entering attic or cutting, put on all personal protection equipment. *This is to reduce the amount of dust particles you breathe, protect your eyes and hands.*

AIR SEALING

- Spray foam. *Assure 100% of the edge and all penetrations are air sealed. The finished foam seal must be rigid and completely covering adjacent framing cracks, holes and penetrations.*

8 - ATTIC CRITICAL DETAIL: ADJACENT FRAMING CRACKS, HOLES, & PENETRATIONS

EXISTING HOME TECH TIPS

(SPRAY FOAM)

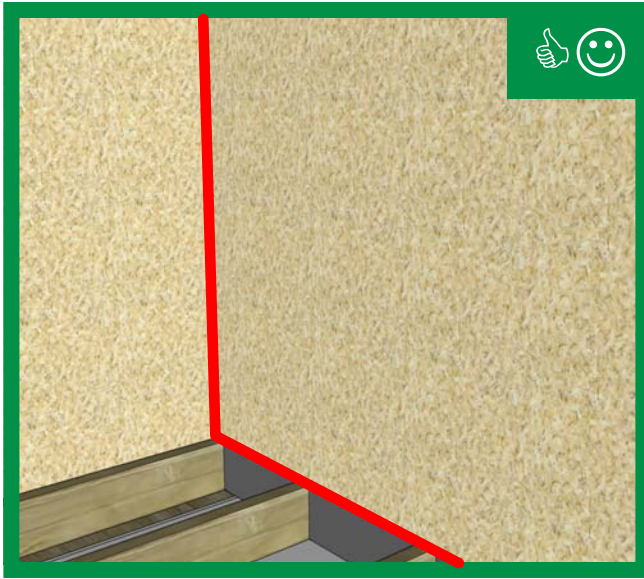

FINAL PRODUCT

9 - ATTIC CRITICAL DETAIL: PLUMBING, WIRING, NON-COMBUSTION & DUCTING PENETRATIONS (SPRAY FOAM)

DESIRED OUTCOME(S)

1. Air does not enter or exit the house through plumbing, wiring, non-combustion venting and ducting penetrations.
2. Adhesion of sealants to all surfaces to be air sealed in order to stop the passage of air.

EFFECTS ON THE HOUSE

Openings to the attic allow heat, cold and moisture movement to/from the attic and house and may result in decreased durability.

EFFECTS ON THE OCCUPANTS

Intrusion of unhealthy air from unconditioned areas, reduced comfort, possible back drafts containing poisonous fumes and higher utility bills.

MATERIALS

Filler Material

Support Material

Fasteners

Sealants

TOOLS

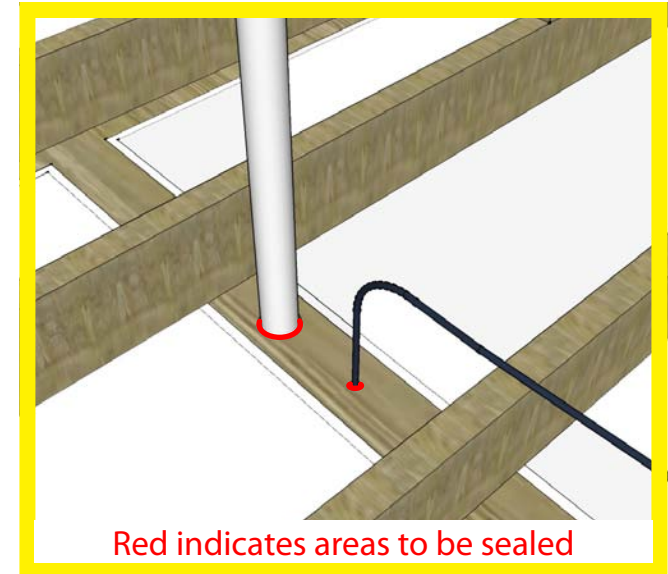
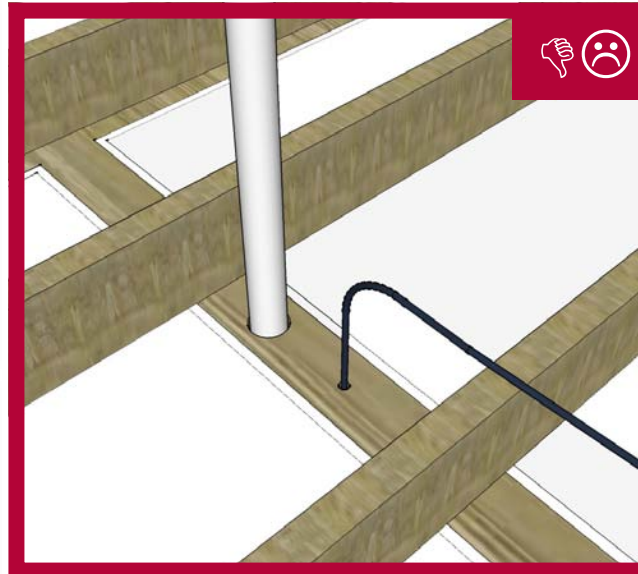

SAFETY

- Before entering attic or cutting, put on all personal protection equipment. *This is to reduce the amount of dust particles you breathe, protect your eyes and hands.*

AIR SEALING

- Spray foam. *Assure 100% of the edge and all penetrations are air sealed. The finished foam seal must be rigid and completely covering adjacent framing cracks, holes and penetrations.*

9 - ATTIC CRITICAL DETAIL: PLUMBING, WIRING, NON-COMBUSTION & DUCTING PENETRATIONS (SPRAY FOAM)

EXISTING HOME TECH TIPS

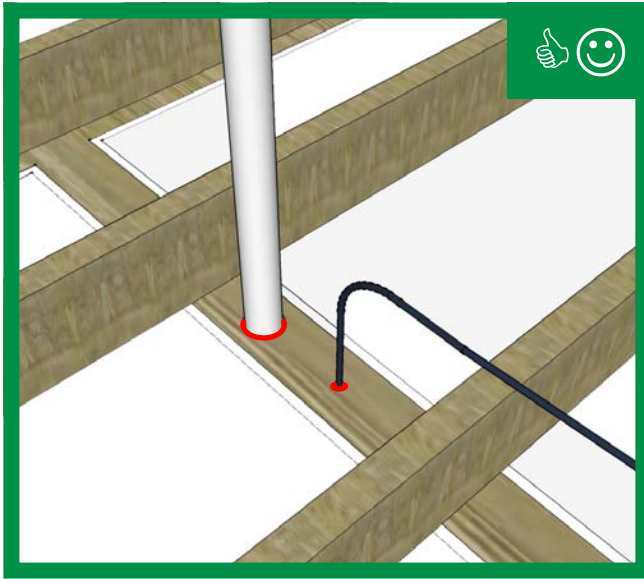

FINAL PRODUCT



10 - ATTIC CRITICAL DETAIL: INTERIOR FINISH PENETRATIONS



EXISTING HOME TECH TIPS

(SPRAY FOAM)

DESIRED OUTCOME(S)

1. Air does not enter or exit the house through penetrations.
2. Adhesion of sealants to all surfaces to be air sealed in order to stop the passage of air.

EFFECTS ON THE HOUSE

Openings to the attic allow heat, cold and moisture movement to/from the attic and house and may result in decreased durability.

EFFECTS ON THE OCCUPANTS

Intrusion of unhealthy air from unconditioned areas, reduced comfort, possible back drafts containing poisonous fumes and higher utility bills.

MATERIALS

Filler Material

Support Material

Fasteners

Sealants

TOOLS

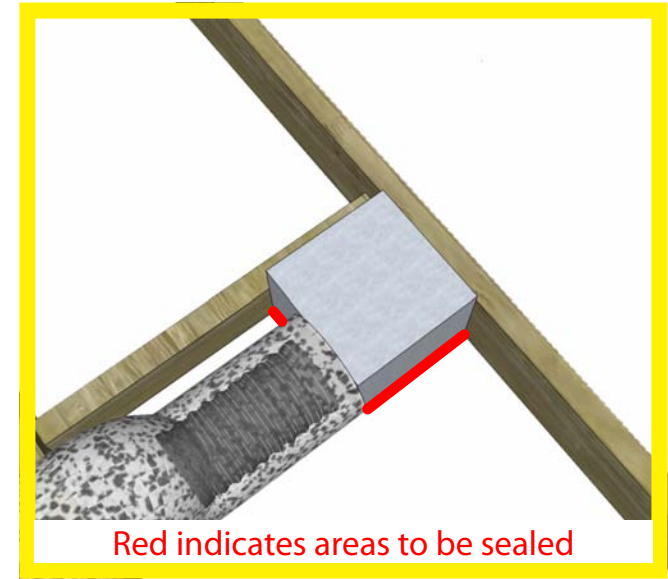
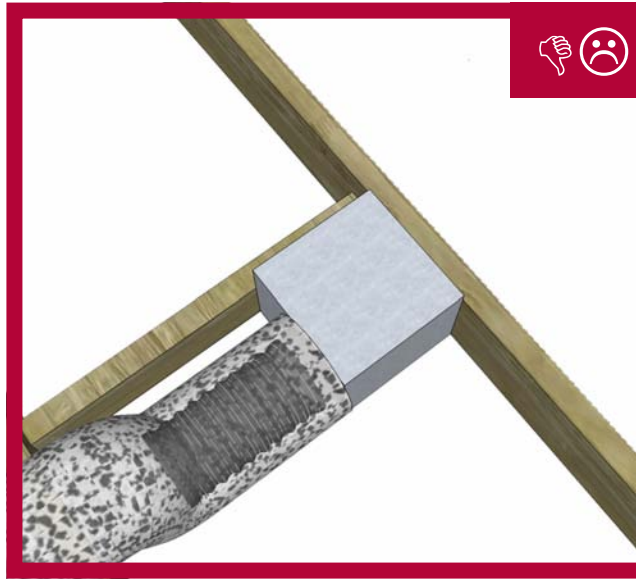

Red indicates areas to be sealed

SAFETY

- Before entering attic or cutting, put on all personal protection equipment. *This is to reduce the amount of dust particles you breathe, protect your eyes and hands.*

AIR SEALING

- Spray foam. *Assure 100% of the edge and all penetrations are air sealed. The finished foam seal must be rigid and completely covering adjacent framing cracks, holes and penetrations.*

10 - ATTIC CRITICAL DETAIL: INTERIOR FINISH PENETRATIONS

EXISTING HOME TECH TIPS

(SPRAY FOAM)

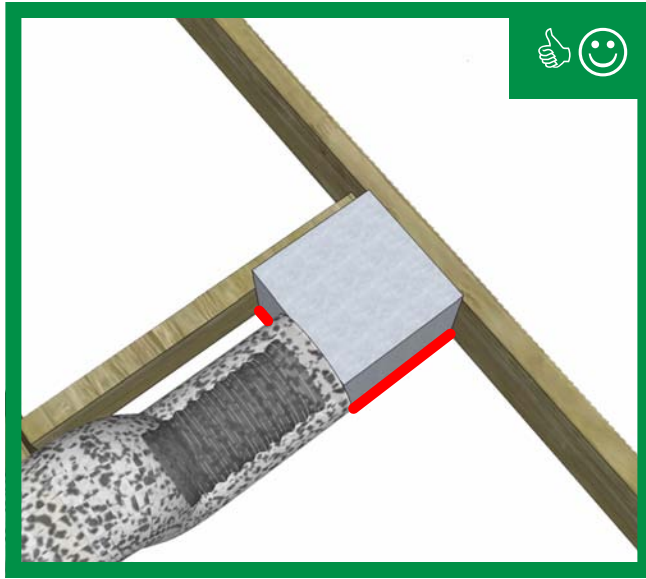

FINAL PRODUCT



11 - ATTIC CRITICAL DETAIL: ATTIC ACCESS HATCHES & DOORS



EXISTING HOME TECH TIPS

(SPRAY FOAM)

DESIRED OUTCOME(S)

1. Air does not enter or exit the house through the attic access hatches and doors.
2. Adhesion of sealants to all surfaces to be air sealed in order to stop the passage of air.
3. All sealants and weather-stripping will stop the passage of air.

EFFECTS ON THE HOUSE

Openings to the attic allow heat, cold and moisture movement to/from the attic and house and may result in decreased durability.

EFFECTS ON THE OCCUPANTS

Intrusion of unhealthy air from unconditioned areas, reduced comfort, possible back drafts containing poisonous fumes and higher utility bills.

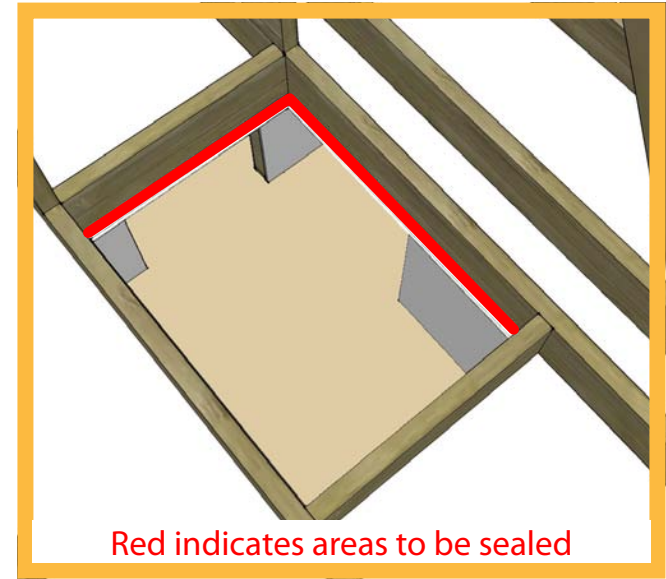
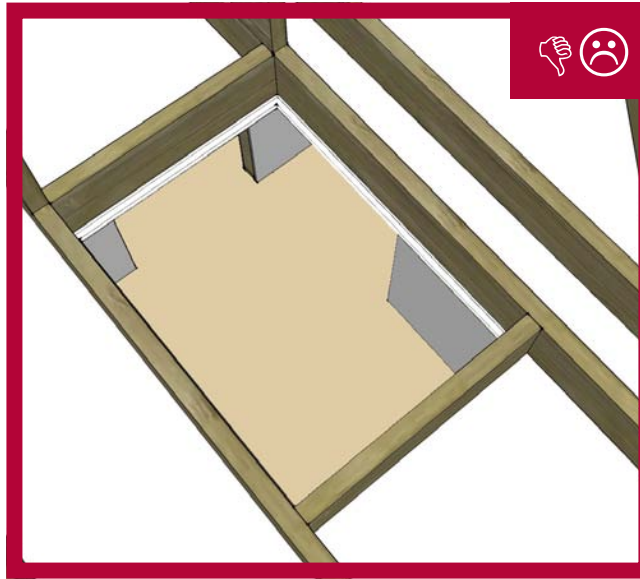

SAFETY

- Before entering attic or cutting, put on all personal protection equipment. *This is to reduce the amount of dust particles you breathe, protect your eyes and hands.*

AIR SEALING

- Air seal **ALL** edges and penetrations. *Assure 100% of the edge and all penetrations are air sealed with [sealants](#).*

MATERIALS

Filler Material

Support Material

Fasteners

Sealants

TOOLS

11 - ATTIC CRITICAL DETAIL: ATTIC ACCESS HATCHES & DOORS

EXISTING HOME TECH TIPS

(SPRAY FOAM)

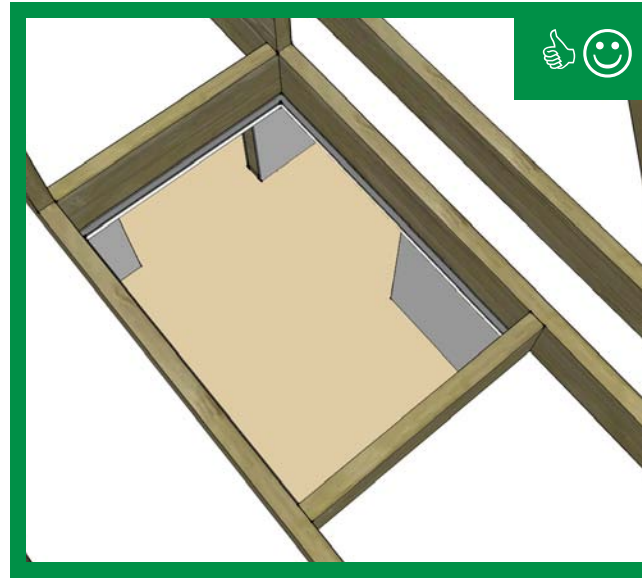
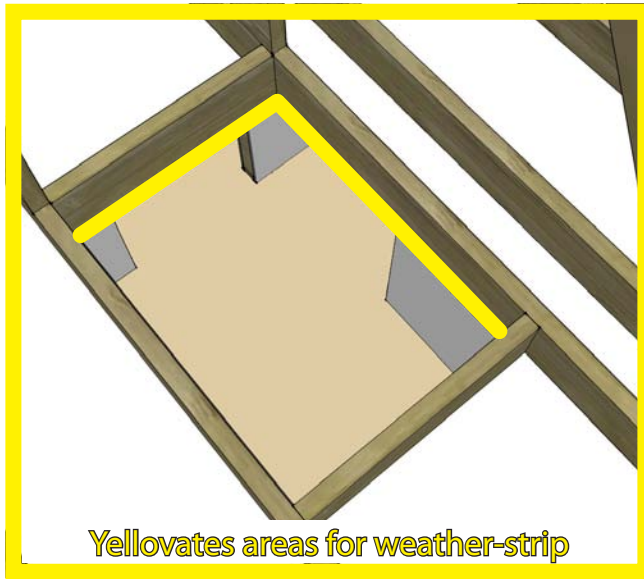

WEATHER-STRIP

1. Weather-strip access hatches and doors

DO NOT USE NAILS

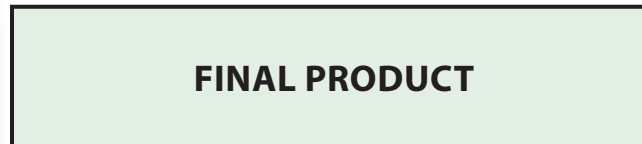

12 - ATTIC CRITICAL DETAIL: FIRE RATED WALL & FLOOR PENETRATIONS



EXISTING HOME TECH TIPS

(SPRAY FOAM)

DESIRED OUTCOME(S)

1. Air does enter or exit the house through the fire rated wall and floor penetrations.
2. Reduce the spread of fire and smoke.
3. Reduce the occurrence of fire due the closeness of air barrier system and a combustion source.
4. Eliminate bending, sagging or movement that may result in air leakage.
5. Eliminate cracking of ceiling materials and nail pops that may result in additional air leakage.
6. Adhesion of the sealant to all surfaces to be sealed in order to stop the passage of air.

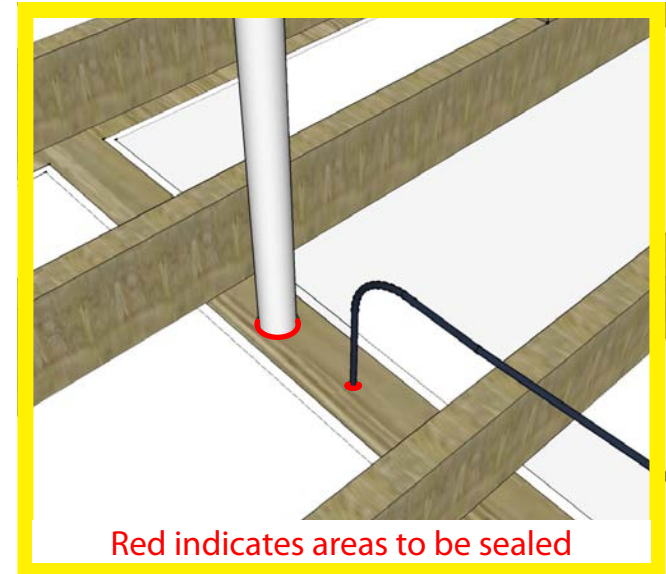
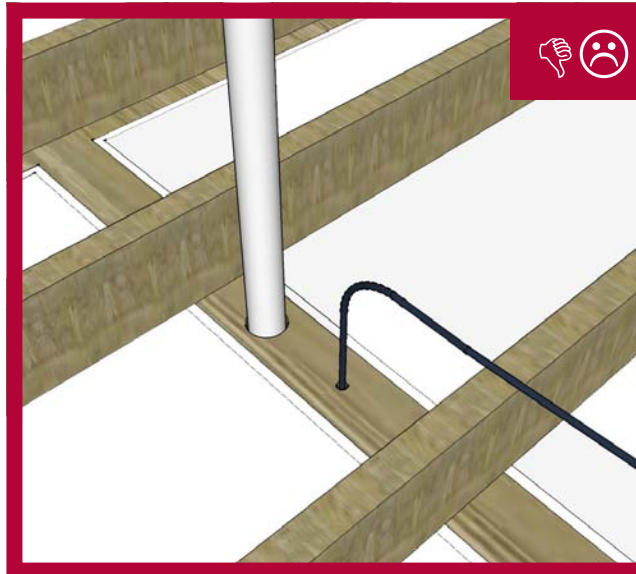

EFFECTS ON THE HOUSE

Openings to the attic allow heat, cold and moisture movement to/from the attic and house and may result in decreased durability.

EFFECTS ON THE OCCUPANTS

Intrusion of unhealthy air from unconditioned areas, reduced comfort, possible back drafts containing poisonous fumes and higher utility bills.

SAFETY

- Before entering attic or cutting, put on all personal protection equipment. *This is to reduce the amount of dust particles you breathe, protect your eyes and hands.*

AIR SEALING

- Air seal **ALL** penetrations through fire rated floors and walls. *Assure 100% of the edge and all penetrations are air sealed with [fire rated sealants](#).*

MATERIALS

Air Barrier

Support Material

Fasteners

Sealants

TOOLS

12 - ATTIC CRITICAL DETAIL: PENETRATIONS THROUGH FIRE RATED WALLS & FLOORS

EXISTING HOME TECH TIPS

(SPRAY FOAM)

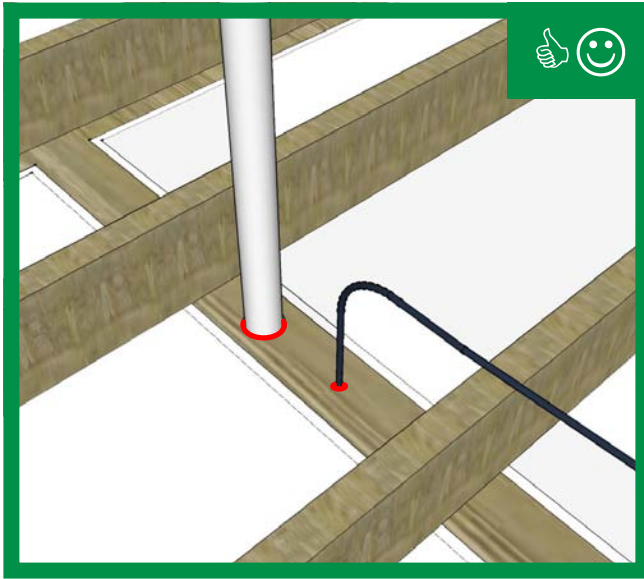

FINAL PRODUCT



13 - ATTIC CRITICAL DETAIL: FLUE, COMBUSTION VENTS & CHIMNEYS



EXISTING HOME TECH TIPS

(SPRAY FOAM)

DESIRED OUTCOME(S)

1. A fire safe air barrier that stops the passage of air into or out of the house through flue, combustion vents and chimneys.
2. Reduce the occurrence of fire due the closeness of air barrier system and a combustion source.
3. Eliminate bending, sagging or movement that may result in air leakage.
4. Eliminate cracking of ceiling materials and nail pops that may result in additional air leakage.
5. Adhesion of the sealant to all surfaces to be sealed in order to stop the passage of air.

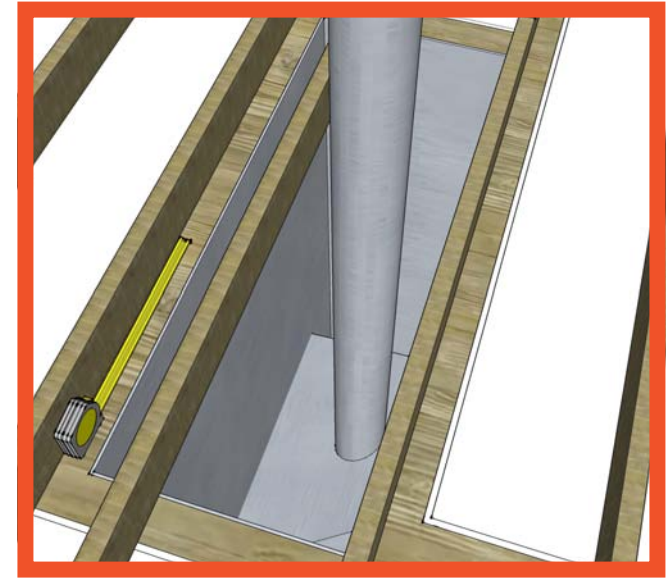
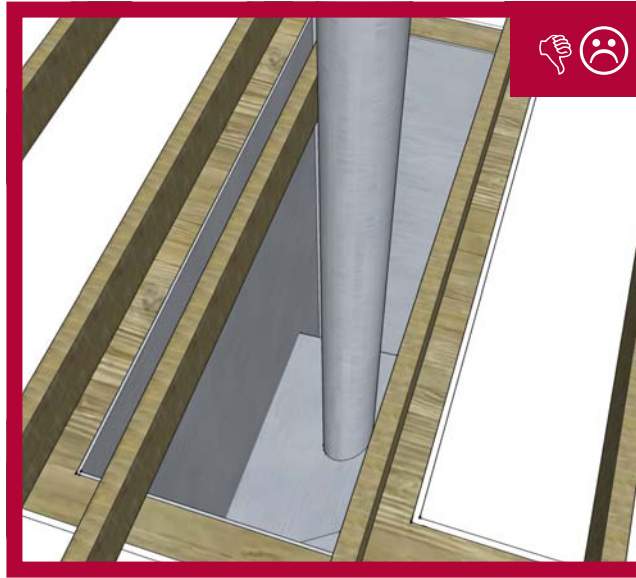

EFFECTS ON THE HOUSE

Openings to the attic allow heat, cold and moisture movement to/from the attic and house and may result in decreased durability.

EFFECTS ON THE OCCUPANTS

Intrusion of unhealthy air from unconditioned areas, reduced comfort, possible back drafts containing poisonous fumes and higher utility bills.

SAFETY

- Before entering attic or cutting, put on all personal protection equipment. *This is to reduce the amount of dust particles you breathe, protect your eyes and hands.*

JOB PREP

- Measure distance of hole and allow for overlap for [fastening](#).
- Cut [metal flashing material](#).

MATERIALS

Air Barrier

Support Material

Fasteners

Sealants

TOOLS

13 - ATTIC CRITICAL DETAIL: FLUE, COMBUSTION VENTS & CHIMNEYS

EXISTING HOME TECH TIPS

(SPRAY FOAM)

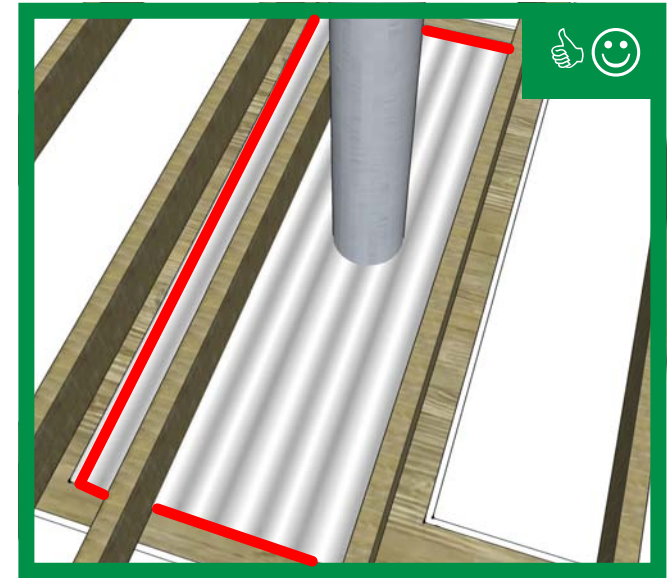
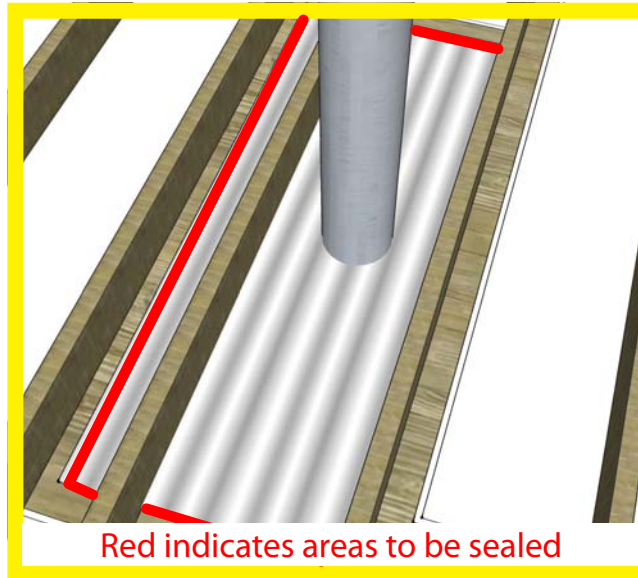
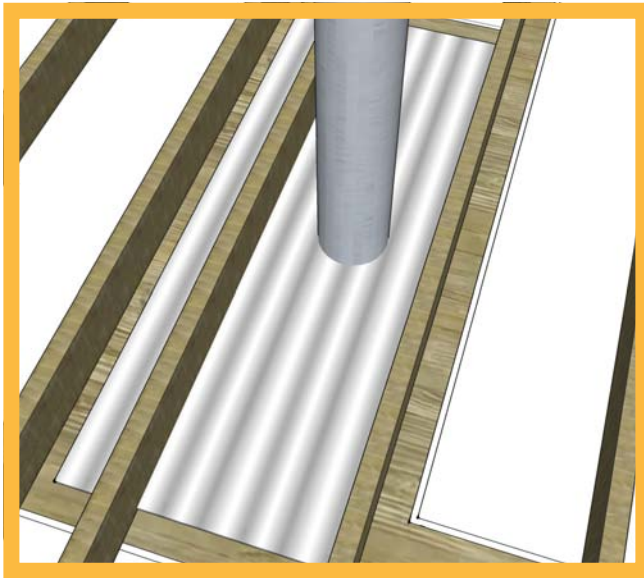

AIR BARRIER

- Fasten [metal flashing material](#).

DO NOT USE NAILS

AIR SEALING

- Air seal **ALL** edges and penetrations. Assure 100% of the edge and all penetrations are air sealed with [fire rated sealants](#).

FINAL PRODUCT

